

IEG1-1REG4-51-20.0-A-01-V

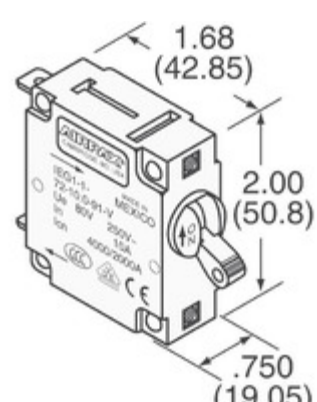

Obrázky jsou pouze orientační.
Podrobné informace o produktu naleznete v části Technické údaje produktu.

Koupit IEG1-1REG4-51-20.0-A-01-V s důvěrou od Component-World.HK, 1 rok záruka



Part Number: [IEG1-1REG4-51-20.0-A-01-V](#)

Výrobce: [Sensata Technologies, Airpax](#)

Popis: CIR BRKR MAG-HYDR

Datový list: [IAG,IUG,IEG,CEG,LEG Series Datasheet](#)

RoHS Status: Bez olova / V souladu RoHS

Ship From: Hong Kong

Shipment Way: DHL/Fedex/TNT/UPS/EMS

[Request For Quotation](#)







PARAMETR PRODUKTU

Part Number	IEG1-1REG4-51-20.0-A-01-V	Výrobce	Sensata Technologies, Airpax
Popis	CIR BRKR MAG-HYDR	Stav volného vedení / RoHS	Bez olova / V souladu RoHS
Dostupné množství	1659 pcs	Datový list	IAG,IUG,IEG,CEG,LEG Series Datasheet
Kategorie	Ochrana obvodu	Napítí - DC	80V
Napítí - AC	250V	Série	IEG
Počet pólů	1	Typ montáže	Panel Mount
Úroveň citlivosti na vlhkost (MSL)	1 (Unlimited)	Stav volného vedení / RoHS	Lead free / RoHS Compliant
Osvětlení napětí (nominální)	-	Osvětlení	None
Jmenovitá hodnota proudu	20A	Breaker Typ	Magnetic (Hydraulic Delay)
Pohon Type	Lever		

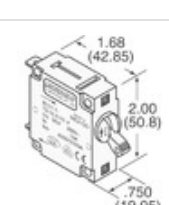
Component-World.com je spolehlivý distributor elektronických součástek. Specializujeme se na všechny elektronické komponenty řady Sensata Technologies, Airpax. Máme 1659 kusy Sensata Technologies, Airpax IEG1-1REG4-51-20.0-A-01-V na skladě dostupných. Vyžádejte si citát z distributora součástí elektroniky na Component-World.com, náš prodejní tým vás bude kontaktovat do 24 hodin.

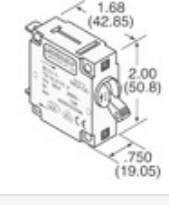
RFQ Email: info@Components-World.com

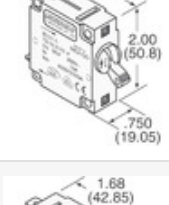
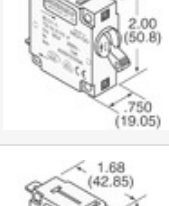
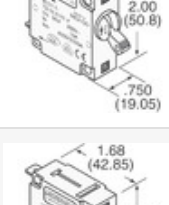
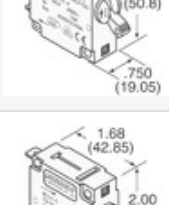
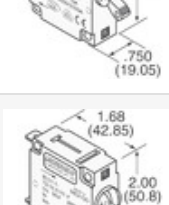
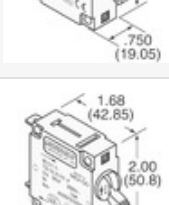
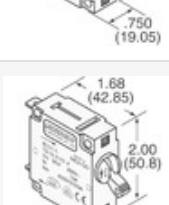
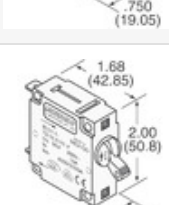
SOUVISEJÍCÍ PRODUKTY

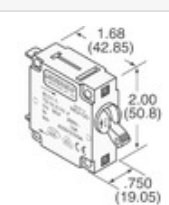
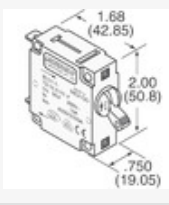
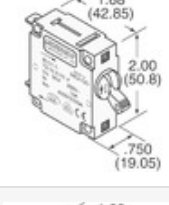
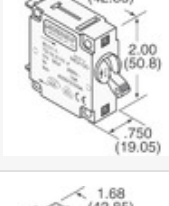
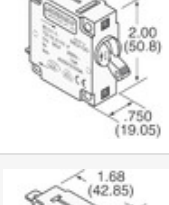
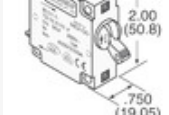
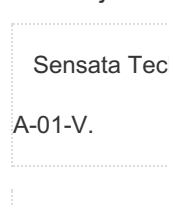
	Část#: IEG1-1REC5-69-100-21-V	Výrobci: Sensata Technologies, Airpax	Dotaz
	Část#: IEG1-1REC5-69-500-31-V	Výrobci: Sensata Technologies, Airpax	Dotaz
	Část#: IEG1-1REC5-69-1.00-31-V	Výrobci: Sensata Technologies, Airpax	Dotaz
	Část#: IEG1-29230-3-V	Výrobci: Sensata Technologies, Airpax	Dotaz
	Část#: IEG1-25715-1	Výrobci: Sensata Technologies, Airpax	Dotaz
	Část#: IEG1-29230-1-V	Výrobci: Sensata Technologies, Airpax	Dotaz
	Část#: IEG1-1REC5-62-.250-91-V	Výrobci: Sensata Technologies, Airpax	Dotaz
	Část#: IEG1-30021-1-V	Výrobci: Sensata Technologies, Airpax	Dotaz
	Část#: IEG1-1REG4-35887-15-V	Výrobci: Sensata Technologies, Airpax	Dotaz
	Část#: IEG1-29230-2-V	Výrobci: Sensata Technologies, Airpax	Dotaz
	Část#: IEG1-1REG4-26371-6-V	Výrobci: Sensata Technologies, Airpax	Dotaz
	Část#: IEG1-26078-5-V	Výrobci: Sensata Technologies, Airpax	Dotaz
	Část#: IEG1-29628-1-V	Výrobci: Sensata Technologies, Airpax	Dotaz
	Část#: IEG1-21478-2	Výrobci: Sensata Technologies, Airpax	Dotaz
	Část#: IEG1-1REC5-62-.250-91-C	Výrobci: Sensata Technologies, Airpax	Dotaz
	Část#: IEG1-1REG4-51-2.00-A-01-V	Výrobci: Sensata Technologies, Airpax	Dotaz
	Část#: IEG1-1REC5-69-500-31-UV	Výrobci: Sensata Technologies, Airpax	Dotaz
	Část#: IEG1-1REG4-51-10.0-A-01-V	Výrobci: Sensata Technologies, Airpax	Dotaz
	Část#: IEG1-30240-15-V	Výrobci: Sensata Technologies, Airpax	Dotaz
	Část#: IEG1-26078-1-V	Výrobci: Sensata Technologies, Airpax	Dotaz

Související klíčová slova pro IEG1-1REG4-51-20.0-A-01-V

Sensata Technologies, Airpax IEG1-1REG4-51-20.0-A-01-V.	IEG1-1REG4-51-20.0-A-01-V distributor	IEG1-1REG4-51-20.0-A-01-V dodavatel	IEG1-1REG4-51-20.0-A-01-V Cena
koupit IEG1-1REG4-51-20.0-A-01-V.	Sensata Technologies, Airpax IEG1-1REG4-51-20.0-A-01-V.	Sensata Technologies/Airpax IEG1-1REG4-51-20.0-A-01-V.	IEG1-1REG4-51-20.0-A-01-V Stáhnout datasheet.
			IEG1-1REG4-51-20.0-A-01-V Stock.